

Magic Bunny

presents

Top Hat

Table of Contents

A Letter from the Editor <i>by Michael Jay</i>	1
The Art of Reading Magic <i>by Gary Scott</i>	2
The Magician's Notebook <i>by Zero Jones</i>	14
Four (Self Working) Card Tricks <i>by Werner Miller</i>	18
Visions of Vernon <i>by Mark Williams</i>	27
The Magician <i>by Michael Jay</i>	29
The Magic of Love - A Valentine's Trick <i>by Jan A. Hand</i>	33
Bizarre Bursary.....	39
Ned <i>by Weepin' Willie</i>	40
End Page.....	45

This table of contents is linked to the articles - just point and click

A Letter from the Editor

by Michael Jay



Finally, Top Hat is back up and running. I'm pleased to see this rebirth of our magazine and I'm sure that the various contributors to our donation drive are saying to themselves, "Jeez, Jay, it's about damn time!" And you're right, it's about damn time. I will offer no excuses for this long, long wait, only a heartfelt apology for taking so very long. However, now that we are up and running, you can be certain that you'll be seeing Top Hat on a regular basis, all through 2018 and beyond.

As stated, all those who contributed are now in line to receive the 2018 book "Classic Magic and the 21st Century Magician" (my working title). The book shall cover a great many topics, useful to the close-up magician, the cabaret magician, the walk-around magician, the professional magician and the amateur magician, as well as the semi-professional magician. I am confident in saying that this book will be well received and an important and useful tool in your library of magic, as well as your arsenal of useful tricks, regardless of your position or genre. Absolutely something for everyone.

Aside from those who've contributed and have gotten in on the ground floor, there is still room to receive this book, which is due out on May 1st of 2018. If you are interested in receiving "Classic Magic and the 21st Century Magician", you have two choices.

The first is a one-time contribution to the continued success of Top Hat via PayPal. You can get in on the book by sending the contribution of \$30.00 to michaeljay1965@yahoo.com on or before February 28th. Please make sure that you include your name and e-mail with that contribution (in the past, the e-mail and name of contributor associated with PayPal has been wrong, so I like to make sure that I have the correct details at all times) and your name shall be added to the list for receiving the book on May 1st.

The second option is to make a monthly pledge of \$10.00 via Patreon, but this pledge must be completed by January 31st, 2018. You can donate to Patreon at the link:

Patreon

You must keep this monthly pledge going for at least 3 months (just as the first offer of a one-time fee of \$30.00 or you'll be removed from the list) and, just as with the PayPal donation, please make sure that I have your name and e-mail address.

You do have a guarantee with this pledge, though. If, after receiving the book, you feel that you didn't get your money's worth, you shall be issued a full refund of the money that you spent. You need only send me an e-mail asking for a refund, and there will be no questions asked. You shall get your money back without question. On that, you have my guarantee, which is issued in writing herein.

As always, past issues of Top Hat can be found at the following locations:

Magic Bunny

FaceBook

Lybrary

Making this contribution does not only offer the bonus of getting the book "Classic Magic and the 21st Century Magician", but also it contributes to the further production of Top Hat Magazine. Even if you choose not to contribute financially, there are other ways that you can contribute - letters to the editor, offering an article for publication, and sharing this magazine with your friends in magic. Please don't overlook those very important ways of ensuring the future of Top Hat as we know it, today.

Without further ado, let's get started on Top Hat!

The Art of Reading Magic

by Gary Scott



Part 3

Old School

- “But all the magic I have know(n), I've had to make myself.”
— [Shel Silverstein](#)

You may have noticed that during my attempt to whet your appetite to learn magic from books, I've been compiling some rather wonderful quotes that I have sprinkled liberally throughout. My research of these passages has me quoting some rather high-profile figures from history as well as more contemporary, modern authors. The strange thing about history is that as I write this, those modern authors eventually, like all things, become part of the past. I do hope you have enjoyed reading the quotes that I've put forward as much as I enjoyed researching them. I believe that I've given you quotes that relate to the study of magic from books and I do hope they inspire you as much as the books themselves.

- “Employ your time in improving yourself by other men's writings so that you shall come easily by what others have labored hard for.”
— [Socrates](#)

Book Care

So on to my dissertation on how to deal with the older books in magic. Let's begin with a little about the care of them. I mentioned in Part 2 (Top Hat vol.2 #12) that I don't like the destruction of books. Filling them with pen marks, high-lighting and bent corners. The first time that you get yourself an old school book, it will be second-hand and may have been through the mill once too

often. The best thing you can do here is look up multiple resources for your book of choice and purchase the best quality version. If you get the book from the internet, you take your chances. A magic shop that sells books usually has some older stock. You may be paying a few more pence than flea-bay but you will be able to check out the quality right from the get-go.

- “There are worse crimes than burning books. One of them is not reading them.”
— [Joseph Brodsky](#)

So you've got hold of your old school book. The first consideration should be where to place it in your library. I have my books that are pre-1950's all together. This way the covers are not mixing with the chemicals that may be on the dust-jackets of modern books. The best possible protection for old books is to get hold of the same type of plastic protectors that surround books in your local library. You can find them here. www.bookprotectors.com. When it comes to cleaning, **DO NOT** use polish on your book covers or their pages. There is enough moisture in the air naturally that clings to paper and is what adds to the deterioration of paper over time. If you have a good, expansive library, then may I suggest a dehumidifier for the room in which your library is located. Of course, nature will eventually end all things but during the lifetime of the book, we can cherish it like our favourite pet and give it protection as it nourishes our appetite for knowledge.

- “Reading furnishes the mind only with materials of knowledge; it is thinking that makes what we read ours.”
— [John Locke](#)

Sleight-of-Hand

So I'm going to take a book that everybody knows and try and help you dissect a piece of sleight-of-hand from Bobo's Modern Coin Magic. First published in

1952, which is not really *that* long ago in magic publishing history, the writing is fresh, up-to-date, easy to follow and the book is crammed with illustrations to help you along the way. Later I'll deal with the older books with no illustrations.

If you have a copy of Bobo's, I'm going to help you read the instruction for 'The French Drop'. (Le Tourniquet Vanish) One of the most basic of sleights that has been readily abused and exposed, yet it is still given full detail here. If you don't have a copy of Bobo's, no worries! This is all about how to digest the information in front of you and not a study of Bobo itself. You can use this information for any book in front of you. I'm using the revised edition that is aptly named Bobo's NEW Modern Coin Magic and you will have to find 'The French Drop' in the contents page if you have a different version.

So turn to page 37 and let's begin.

- “The more that you read, the more things you will know. The more that you learn, the more places you'll go.”
— [Dr. Seuss](#),

So you've set up the tome in your book stand and it's at the appropriate page. I'm going to extract a few paragraphs that shows the best examples of teaching via the written word. Ok, we'll begin with the second paragraph.

With the left hand palm upward, hold a half dollar by its edges between the tips of the left fingers and thumb, tilting the rear of the coin up slightly so its face can be seen by the spectators.

As you can see, the text is very clear in its approach to instruction and the illustrations do help but let me give you my thoughts and translation as to what is important in the above.

Although the first line reads as though the left-hand is a must, reversing the procedure to bring the right-hand into play is just as effective. All sleight-of-hand methods, from any book, are usually described with right-handed people in mind due to the more common nature of the right-hand being dominant. The important thing here is not to hold the coin in a death grip as even without a

diagram, this description can be interpreted as all fingers are involved. The illustration in the book does not include the little finger. This initial paragraph is all about the display of the coin. Over time you will make your own adjustments as I now perform 'The French Drop' coin display with the coin only being gripped by the middle-finger and thumb. *Tilting the rear of the coin up slightly* can be misinterpreted as the tail side of the coin needs to be in a certain position but the coin can be any side facing. The tilt motion comes from the wrist as it turns 90° to the left to allow the coin to be displayed at the fingertips in a palm-up position.

Bring the palm down right hand over the coin, the thumb going underneath it and between the left thumb and fingers. Lift up and close the right hand, pretending to take the coin away from the left, but allow the coin to make a half turn forward as it slides down to the base of the second and third fingers of the left hand where it is finger palmed.

Your left hand is still displaying the coin as you perform the fake taking action with the right hand.

Allow the coin to make a half turn forward; sounds like the coin should rotate when in fact all that happens is the coin drops into left finger palm by releasing the pressure of the left thumb ever so slightly. This is something that should be practiced as this particular exercise (going from a display to finger palm) is used in other sleights. The two book illustrations in regards to 'The French Drop' are shown in the display position and the finger palm position. Imagine how the coin gets from one position to the other. Now make it happen with minimal movement of the thumb to eradicate any tell.

Keep the left fingers together during this action or the coin may be glimpsed by the onlookers. Move the closed right hand to the right and downward and turn it fingers uppermost, keeping your attention fixed on it. Turn the left hand back toward the spectators and point to the closed right hand as it "crumbles" the coin away. Open the right hand and show it empty.

You can see that the writing here keeps with the same standard as the previous paragraph. You will find in Bobo's that all the instruction is written in this manner. So here is the dissection of the first sentence.

This could be interpreted as the onlookers seeing the coin from above when in fact it means that the left fingers need to remain together so the coin does not show through the natural gaps in the fingers that we call 'windows'. Here's a tip. Everybody's hands are different and you may have 'windows' that are larger than normal. This is where you start the thinking process. What adjustments do I make to avoid this? Do I need to angle my hand differently? What are my lighting sources and are they going to reflect the coin through the fingers? Can I work on my hand flexibility to maybe close the 'windows'? I'm sure there may be plenty more questions for you to ask yourself about this and your own personal handling and that's one of the joys of reading. Your own personal interpretation to suit your own needs.

Now the second sentence teaches you the taking process. Rotating your closed, right hand from palm down to palm up naturally places the right hand a good few inches away from your dirty left hand. Rotate your arm at the elbow for a more natural motion. Keep your focus of attention on the right-hand as it moves. This directs the audience to follow your gaze and help with the complete belief that what you are doing is a true action. Make sure that you believe that you are really taking the coin and it will show in your expression, demeanor and attitude to what is taking place.

By turning the left hand palm down, you can hide the dirty coin in finger palm yet show the palm empty. This is called 'The Ramsay Subtlety' accredited to magician John Ramsay of Scotland (1877-1962).

The third sentence gives us an opportunity to practice natural movement with 'The Ramsay Subtlety'. A good use of movement would be to point to your eye and say "watch" and then drop the pointing left finger towards the right hand as you make the coin vanish.

For more on 'The French Drop' I would highly recommend you study the works of Gary Kurtz and Homer Liwag.

- "It's still magic even if you know how it's done."
— [Terry Pratchett](#)

Old School Trick

I've just broken down three main passages from a very common sleight and I do hope that you can see that learning sleights from a book is not that strenuous a task. The study of sleight-of-hand is the same no matter the age of the book. An unusual problem occurs when you come to certain tricks in the older books. There are chemicals used for specific tricks that would now be considered dangerous, highly toxic and life-threatening. There are also tricks that require construction of some kind such as a carpenter or steelworker. These kinds of trades are pretty much redundant on an independent level in the 21st century. Let me continue with a book that comes from the golden era of magic where the text is of an earlier style of language and the tricks need a lot more interpretation.

- “A room without books is like a body without a soul.”
— [Marcus Tullius Cicero](#)

I've come across a good example of *Old vs. New* language in *Modern Magic* by Professor Hoffmann.

The book itself was first published in 1876. This is a book that everybody should have in their library and you don't need to have an original edition.

I have one of the fifteenth editions and to be honest it's not in that good a shape. Still no matter the condition, the information is just the same. Pg 295 is where we come across a trick known as The Ball Box and is now known worldwide as The Ball and Vase. For some strange reason, this trick has been the staple of many a child's magic set; Made from plastic and really badly constructed. The good Ball Boxes are made from wood and have lot of intricate detail. If you do a lot of research, you'll find the right Ball Box at the right price for you. There is an actual difference between Ball Box and Ball Vase and the description of Ball Vase follows the Ball Box in *Modern Magic*. The Ball Vase is

a highly professional constructed piece built by a woodworker. It removes all the grooves that are apparent in the Ball Box and attempts to fool by design more by making a smooth edged vase, hence the name. It is also more mechanical in nature by having a push down stud or button that releases a hidden shell from the lid.

- “I want to be magic. I want to touch the heart of the world and make it smile. I want to be a friend of elves and live in a tree. Or under a hill. I want to marry a moonbeam and hear the stars sing. I don't want to pretend at magic anymore. I want to be magic.”
— [Charles de Lint](#)

So let's take a look at The Ball Box.

Here are a few paragraphs to highlight the older use of language.

The main effect is produced by mechanical means, any sleight-of-hand employed being rather an accessory than the leading feature.

In today's verbiage, the term *mechanical means* would be replaced by 'gimmick' which would be false. The older books did not use a generic term for any apparatus used that eliminated or reduced sleight-of-hand. Each trick was described upon its own merit with fully functioning details. As the illustrations were minimalistic the instructions had to be dead on.

The ball-box is generally of turned boxwood and is scored with concentric circles which serve to disguise its double opening.

Boxwood is a type of shrub that has a tree like base. I can only assume, that as a shrub, it is more cost effective and easier to deal with due to the mass volume available. This sentence features the phrase *concentric circles*. This is where your dictionary comes in handy. The basic meaning of concentric is any number of shapes that share the same centre. The circles on an archery target is a good example of this.

The ball is then got rid of in one or other of the modes before described, and a pretence is made of passing it invisibly to the box.

Notice how the words before and described would be reversed in today's speak. The phrase: *and a pretence is made of passing*, as used in magic, is the older term as used when describing a false transfer of any kind. Today we use the term passing for performing a shift with a deck of cards.

So passing or performing a pass has switched to a false transfer yet shifting a deck of cards has now become passing or performing a pass. I have no idea why this has changed or become the natural state of things.

- “One glance at a book and you hear the voice of another person, perhaps someone dead for 1,000 years. To read is to voyage through time.”
— [Carl Sagan](#)

Old School Danger

So here's another example of old school magic and a trick that involves a very dangerous chemical.

The book is Blackstone's Secrets of Magic. This is the new, revised edition and was published in 1958. The trick is 'The Red Hot Ball' and is located on Pg 38. The idea is that of a brass ball resting on a stand to which the spectators examine. As they hold on to ball it becomes very warm until it becomes too hot to touch.

The basic idea is to have quicklime (calcium oxide which is in a crystallized state at room temperature) and sulphuric acid inside the ball. When the spectators examine the ball, chemicals mix and you get the heat reaction. So now we're into the realms of how do I get hold of sulphuric acid? The simple answer is you DON'T! Playing with any kind of acid for the sake of effect should really be avoided. Sulphuric acid may have been available at the local drug store back in 1958 but today it's even easier as you can make it at home. My issue with this kind of trick is the potential for something to go wrong. Horribly wrong. All I keep thinking is lawsuit. Can you imagine if that ball splits open on your spectators? I can understand playing with this kind of thing in a science

lab under controlled conditions but this should truly be left alone and not be used as a magic trick. So what else can we surmise from this effect? Well there are no warnings written in the book. That means that authoring was intended for adults. None of the older books were written for children and tricks like this are one of the pieces of evidence we can use to say that magic was never meant for children to play with.

- “She was fascinated with words. To her, words were things of beauty, each like a magical powder or potion that could be combined with other words to create powerful spells.”
— [Dean Koontz](#),

Our Written History

So what have we learned from my expositions? Hopefully you've seen that I've readily made available my way of dissecting information from a book. The older tomes show how much language has changed. Back then we can see a more formal structure. Writing was the main form of communication and although today, heads are buried inside the world of electronic media, we still need language in written form. There is another issue I wish to address and it's to do with the history of language and what it reveals. This is text that is quoted straight from the original 'Tarbell Course in Magic'. To follow along, you can access the 'Tarbell Course in Magic' for free via MagicBunny.co.uk .

We go to lesson 3 and the section dedicated to Necromancy and Divination. There is a section called *Among Wild Natives of Australia*.

Here is the quote :

*The Australians, **like other barbaric tribes**, do not believe that a man can die of causes other than being slain or being bewitched. When a native dies a natural death, it is believed that some hostile sorcerer caused it.*

As you can see, compared to the likes of today, the highlighted expression would not be acceptable in our overtly and mostly ridiculous politically correct world. There have been several thoughts on updating the older text to eliminate

some of the older, more relaxed points of view. If we do this then we eradicate history. We are re-writing history to suit the modern world. This should not be so. The history of the world did not begin yesterday. We should embrace the past and learn from it. Apologies if this small diatribe seems like a political outburst, but we have fallen into a world where people use the word *offended* at the drop of a hat. Let's take this writing, learn from it. Learn about the history of the people of that time and how they saw the world, how they wrote about it and more importantly for us, how they wrote about magic.

- “What an astonishing thing a book is. It's a flat object made from a tree with flexible parts on which are imprinted lots of funny dark squiggles. But one glance at it and you're inside the mind of another person, maybe somebody dead for thousands of years. Across the millennia, an author is speaking clearly and silently inside your head, directly to you. Writing is perhaps the greatest of human inventions, binding together people who never knew each other, citizens of distant epochs. Books break the shackles of time. A book is proof that humans are capable of working magic.”

[*Cosmos, Part 11: The Persistence of Memory* (1980)]”

— [Carl Sagan](#).

Think about this for a moment....You've just read my article. Hopefully you've managed to make it through all three. If that's the case, you're already someone who is a reader and interested in magic via the written word. I do hope the art of reading magic has become less daunting for you and that you've enjoyed reading my trilogy as much as I've enjoyed writing it. In my quest to give you knowledge about reading magic, I have only scratched the surface on what's available. A mere raindrop in an ocean of information. If you go out of your way to research the best magic has to offer in book form, you won't be disappointed. Thank you for taking the time to read this and anything else that I may have wrote that has peaked your interest in former issues of Top Hat.

- "We are the music makers and we are the dreamers of dreams..."
— Willy Wonka

Good luck on your quest to seek out magic within the pages of your existing or maybe even brand new library. The greatest gift a human being can give another is the wisdom of experience. Let me leave you with one final quote...

- "I am a part of everything that I have read."
— [Theodore Roosevelt](#)

Siya on the boards.

Did You Know?

Born in Melbourne, Australia, in 1901, Leo Norman Maurien Murray Stuart Carrington Walters, known professionally as Murray, was considered one of the top illusionists of his day. Mainly, though, he was known worldwide for his escapes, under the moniker, "Murray, The Escape King" (going so far as to be thrown into the Thames River while handcuffed and chained). Murray came to his greatest fame shortly after the death of Houdini, which was perfect timing because Houdini was known for attacking any escapologist of his day. In his later years, Murray continued to maintain a presence in the magic community, attending conventions until his death in 1988. Unfortunately, few in the magic community remember him.

The Magician's Notebook

by Zero Jones



'Keep a messy notebook.' -*Jim Steinmeyer, Reel Magic Magazine, issue 35-*

The title of this article may appear more appropriate for a fantasy novel, but it actually describes one of a magician's most powerful tools. Eugene Burger was the first magician I remember recommending keeping a notebook, in his own excellent book, 'Mastering the Art of Magic' (2000 edition, page 21). In my opinion, keeping a notebook is vital; everyone has had the experience of having a good idea, not writing it down, and then later found they only have the vaguest memory of the original idea. As an example of how important some magicians consider keeping notes, when you go to Justin Higham for magic lessons, all he asks you to bring is a decent deck of cards, and a notebook.

Eugene Burger was not the first magician to keep a notebook of course. Imagine all the magical knowledge which would have been lost to history if dead magicians had not kept notebooks. We can still read the likes of John Hilliard's notebooks. If it was not for Ottokar Fischer, much of the work of Hofzinger might be unknown to us, as the master magician himself had ordered all his notes to be destroyed after his death. Dr Will Houston discovered the notebook of an anonymous 18th Century magician, giving a great insight into ordinary magical thinking at that time, and you can read about it in Dr Houston's book, "The Notebook" (see Appendix A).

A magician's notebook is as varied in form and contents as any magic performance. They may be simple journals, or a place to jot down your own ideas, and those of others. Those notes could be a vital record of all the magic you've done, or plan to do, or a combination of both. You have to decide for yourself what to fill your notebook with, and how to get the most out of it.

For example, If any of you use your notebooks to write scripts (yes, some magicians write scripts!), Garrett Thomas has an interesting tip on how to layout

your script, inspired by musical notation. Those who subscribe to 'Reel Magic Magazine', can find Garrett talking about his idea, in issue 42, as part of his 'Try This! (at Home)' column.

I have a page in the front of my notebooks dedicated to planning my progress in magic. Long term goals are written at the bottom of the page (whether those goals are learning a new sleight, planning a new cabaret act, or one day turning professional, is really up to you). Next you plan all your short and medium term goals, and write them above the long term ones (short term at the top, medium term in the middle, naturally). This way you can tick off your goals as you achieve them, and have concrete evidence that you are on the right track to fulfilling your ambitions. This little tip has been useful for me, and I hope it will be for you also.

Some magicians keep every record of their work carefully neat and filed. Others follow Jim Steinmayer's advice, and keep their notebooks messy (this is my method.) A messy notebook helps to stop you self-censoring your ideas, deciding in advance what is worthy to go in the notebook. Messy notebooks also increase the chances of you spotting incongruous juxtapositions and so encourage creative thinking.

In reality, it doesn't matter how you keep your notebook. After all, no one is ever likely to read it except you. There is nothing stopping you writing your ideas on random pages, however, if you want to impose a little more order to your notes, there are some good tips around to help you. Try Googling 'tips for organising a notebook'.

The absolute simplest way to bring some order to a notebook must be to write the date on every page when you use it, but if you are using your notebook for something more complicated than a journal, there are better methods to insure you can find what you've written easily.

A tip I've picked up in my research, and intend to institute with my next notebook, can be found at the website above. There, they suggest that you leave the first few pages of your notebook blank, and as you fill it up, you can write down the subject (and page number) in the front, thus creating a contents page as you go.

If you are into arts and crafts, I'm sure you can imagine many ways of differentiating between different sections of your notebook. A very good idea, if you only want to split your notebook into two sections (a journal, and an idea jotter, for example), is to write one part on one side of the pages, then flip the whole notebook over, and write the other stuff on the reverse side of the pages. There is also a very clever 'Japanese Notebook Hack', for those who can't be bothered to number their pages, but I will leave that for you to discover, at this website:

<http://blog.highfivehq.com/a-little-known-hack-from-japan-to-get-your-notebook-organized/>

One important point, your notebook is only ever useful if you have it to hand.

'Like most magic ideas, I can't remember how they came about but rather occurred to me in a flash and I'm scrabbling for a notebook before I forget it.' -*Elliot Hodges, Magic Bunny-*

I suggest we all follow Elliot Hodges example, and keep our notebooks with us at all times, you never know when inspiration will strike. There is no rule against carrying a small notebook to jot down ideas while you are out, and then transfer the best ideas to your 'proper' notebook later (this is something I do myself).

This leads to my final point, and what I consider the most personal, and least important, the physical structure of your notebook. A notebook can be random scribbles on the back of envelopes thrown in a box, or an ornate leather bound tome with a big brass lock (as a vegetarian, I would forgo the leather binding), as long as it works for you.

For those magicians who value looks, and don't worry so much about cost, there's the quality notebooks from the company, 'Moleskine':

<http://www.moleskine.com/en/>

I personally use these hard back notebooks:

<http://www.clarkesofficesupplies.co.uk/storefront/Banner-Casebound-Notebook-A5-Ruled-192-Pages-Ref-9100016-P-828440#.Vlx3kOn5wzU>

I get them in packs of five, and use them both as my magic notebooks, and for my creative writing. It is also worth looking for them on E-bay, as you can sometimes find a good deal. I heartily recommend them.

With the advent of Personal Computers, Tablets, and Smart Phones, some people think pen and paper may be dying out. I know that some swear by Evernote, for example:

<https://evernote.com/?var=2>

At the risk of appearing a bit of a Luddite, I have no experience using electronic devices for note-taking, so I will leave them for someone better qualified to write about.

In this article I have encouraged those who don't, to keep a magic notebook. It does not matter if you tattoo your notes on your body, or use the latest electronic personal organiser, it is only important that you have a record of your thoughts. Remember, the magic is not in the paper and ink, but in the ideas contained in your notes.

I will finish with one other good use for a notebook, suggested in the same Jim Steinmeyer interview ('Reel Magic Magazine', issue 35), from which the opening quote of this article came. Jim says the real pleasure of keeping a magic notebook, is in one day having the leisure to re-read old ones, and develop ideas long forgotten.

And finally, to end this article, some wise words from our resident Magic Bunny Guru, Michael Jay:

'Keep studying, keep learning and continue to keep notes in your notebook.' -Michael Jay-

Four (Self-Working) Card Tricks

by Werner Miller



The Austrian Equivalent

This was inspired by Karl Fulves' *The English Equivalent* (*The Book of Numbers*, 1971, p. 34).

Effect

The spectator selects and remembers one of four card pairs, and the performer locates that pair. (Actually, a minimal version of the ancient *MUTUS DEDIT NOMEN COCIS*.)

Presentation

Sort out the Kings and the Queens and deal them face up into four pairs according to their suits.

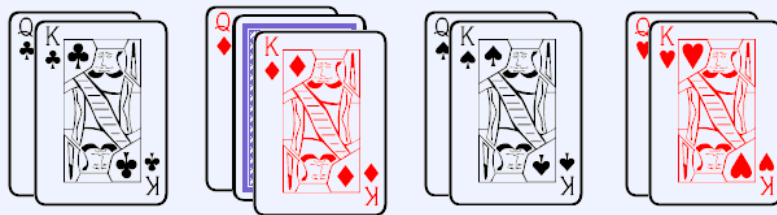

(The order of the suits does not matter.) Hand an Ace (or a Joker) to the participating spectator, then turn away and give instructions as follows:

"Decide on any of these four pairs and remember it. Place the Ace face down between the face-up cards of your selected pair, so that everyone in this room – except me – knows your selected pair, too."

"Combine the three pairs and the group of three to one single packet by dropping them one on top of the other, in any order you like."

"Turn over the entire packet. The Ace is now the only face-up card, all the other cards are face down."

"Give the packet a complete cut."

"Deal the cards singly and alternately into two smaller packets: left, right, left, right and so on. One packet will have one card less – don't care. Place either the left-hand packet on the right-hand packet or the right-hand packet on the left-hand packet – your choice."

"Once more, cut the cards."

"Deal the cards back and forth again. As before, put either packet on top of the other."

"Repeat the whole procedure one last time: cut the packet, deal the cards into two smaller packets, and assemble the packets in any order."

"Done? OK, I think the cards are now thoroughly mixed."

Turn back, take the packet and cut the face-up Ace to the top.

Remove the top two cards and table them. Slide the cards slightly apart, so that the back of the face-down card is partially shown under the face-up Ace.

Remove the next two cards, turn them over, fan them and place them face up on the table. The pair consists of a King and a Queen of the same suit, e.g., KH and QH. Say, "You did not select the Hearts."

Do the same with the next two cards: remove them, turn them over, fan them and table them. The suits match again, e.g., QS + KS. Say, "You did not select the Spades."

Repeat this once more, turning up, e.g., the other black couple. "You did not select the Clubs, . . ." You are left with one single card. Turn it over with your right hand: it is, e.g., the KD - ". . . but the Diamonds!"

At the same time take with your left hand the face-down card from the first pair, turn this card over, too - it's the QD - and place both cards face up side by side on the table.

More than 9 cards

The same modus operandi works with 17 cards as well, but you would have to deal *four* times - that's too lengthy. (Nevertheless, note the connection to the powers of 2: $9 = 2^3 + 1$, $17 = 2^4 + 1$.)

Let's look for a practicable alternative. Dealing 15 cards twice sounds reasonable, doesn't it?

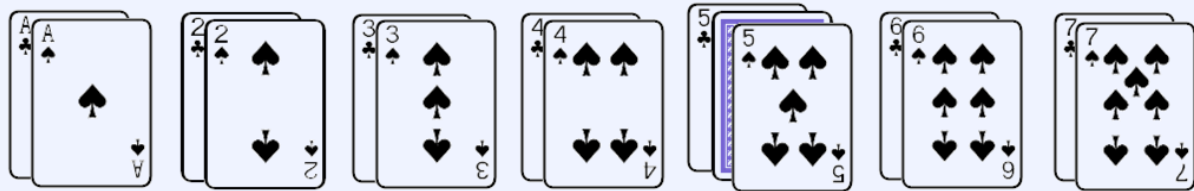

Sort out the values A, 2, 3, 4, 5, 6, 7 of both black suits, and deal them face up in a row of matching pairs, in ascending order.

Hand a red King (or a Joker) to the spectator. As in the 9-card version, the spectator places this card face down between the two face-up cards of any pair, assembles the pairs and the group of three in any order, turns over the combined packet and cuts it.

From now on the things become different:

Instruct the spectator to deal the cards singly back and forth and to watch the face-up King: In which pile will this card end up? Having dealt all the cards, *the pile containing the King is to be placed on top of the other pile* (i.e., the spectator is not free to combine the piles either way as in the 9-card version).

The spectator gives the cards a complete cut, then they are dealt as before and again the pile with the King goes on top of the other one.

Now it's your turn:

Cut the face-up King to the top, remove it, and place it on the table.

"Milk" off the top card and the bottom card of the packet, and place this face-down pair next to the King. Repeat this "milking"-off five more times, placing each pair next to the foregoing one. You are left with two cards; place them as the last pair at the end of the row.

Turn over the first pair: the values don't match.

Turn over the last pair: the values don't match.

Turn over the second pair: the values don't match.

Turn over the next to last pair: the values don't match.

Turn over the third pair: the values don't match.

Turn over the fifth pair: the values don't match.

One pair is still face down: the fourth (center) pair. Turn it over: *the values match!*
It is the pair the spectator selected and marked by placing the King in between.

(From my e-book "Enigmatics 6", <http://www.lybrary.com/werner-miller-m-7881.html>)

Cardician's Solitaire

How does a magician play solitaire? Maybe as follows.

After having shuffled and cut the deck the top card is turned over and placed face up on the table. The performer spells the full name of this card dealing a face-down card with each letter, forming a separate pile for each word. Then the next card of the deck is also turned face up and its name spelled in a similar way and so on until the deck is exhausted. The goal: to deal the last card of the deck when the last letter of a suit is spelled, i.e., one loses when the cards run out before a spelling has been completed. Sounds like a real challenge, doesn't it? But not for a cardician, of course. He wins the game with ease and finishes the demonstration by presenting an extra surprise: When the top cards of each pile triplet are turned over, they turn out to be of the same value as the spelled card, i.e., the performer somehow managed to get always four of a kind.

To achieve this effect you need a full deck stack. Arrange the cards

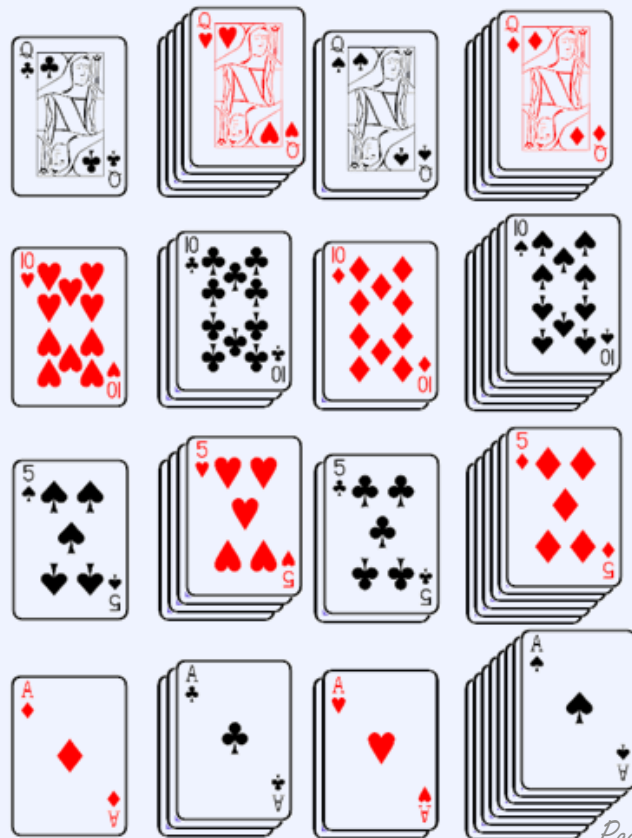
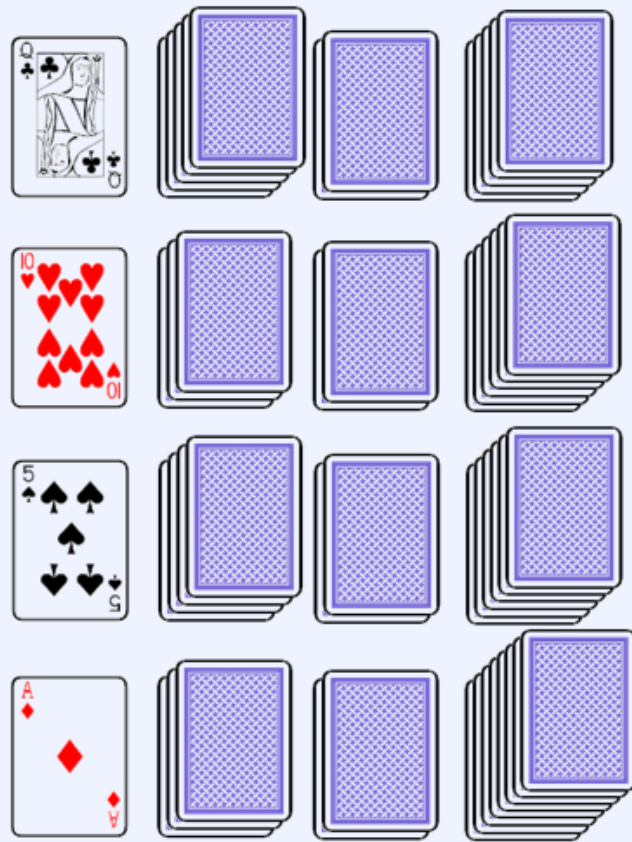

from the top down as follows (x = indifferent card):

QC - x - x - x - x - QH - x - QS - x - x - x - x - QD - 10H - x - x - 10C - x - 10D
- x - x - x - x - x - 10S - 5S - x - x - x - 5H - x - 5C - x - x - x - x - x - 5D - AD - x
- x - AC - x - AH - x - x - x - x - x - x - x - AS.

Start by giving the cards a false shuffle and a false cut, then proceed as described. The rest is showmanship.

(From my e-book "Enigmaths 7", <http://www.lybrary.com/werner-miller-m-7881.html>)

Court-Die-ally

Effect

Via rolling a die, the twelve court cards are sorted into Jacks, Queens and Kings.

Presentation

Remove the twelve court cards and sort them openly into suits, taking care that the cards of each suit are in the same order (J-Q-K).

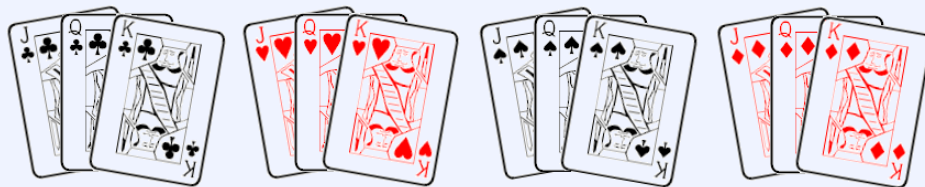

Ask the spectator how to put these 3-card piles on top of each other and assemble the cards accordingly. Then square the cards, turn the packet face down, and have it cut by the spectator. (This does not affect the cyclic order of the cards; the 1st, 4th, 7th and

10th cards are still of the same value, also are the 2nd, 5th, 8th and 11th and the 3rd, 6th, 9th and 12th.)

Perform a *Klondyke Shuffle*. Repeat the mixing, but this time don't deal the milked-off pairs into a pile, place them side by side into a row, from left to right or from right to left (*Distributing Klondyke Shuffle*).

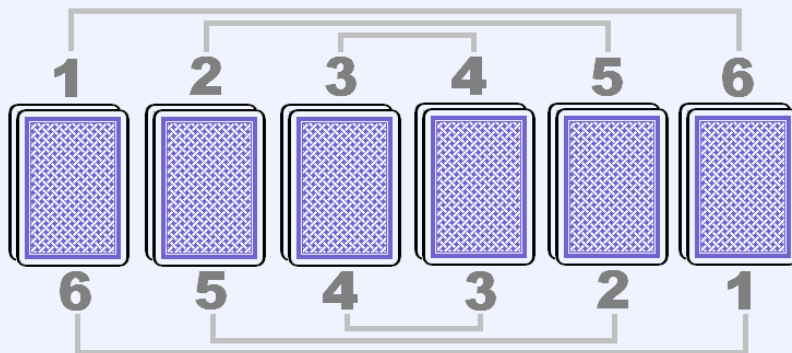

Hand a regular die to the spectator and ask the spectator to roll it, thus designating one position in the row. Count aloud to the rolled number while tapping the backs of the cards in turn. You may start either at the left end or at the right end of the row (spectator's choice). The pair you end up is moved out of the row. Now instruct the spectator to turn over the die to get a new random number (the 7-complement of the first one, in fact). Again, count to that position and slide out the pair in question, but start at the same end of the row as before. (If you are passing the first pair; tap/count it, too, don't skip it!)

Drop the two located pairs – still face down – one on top of the other, and place these cards before the spectator who rolled the die.

The die is handed over to another spectator, and the whole procedure starts again. Instruct the spectator to roll the die until a number shows up that is different from the ones the first spectator rolled. Locate the first pair by counting to that position, have the die turned over, and locate the second pair by counting to the complimentary position, both times starting at the same end of the row and including the vacant positions. (Don't skip the gaps!)

As with the first spectator, the two located pairs are dropped one on top of the other and placed face down before the person who rolled the die.

Two pairs are left. Assemble them, turn the cards over and spread them: the values match (e.g., four Jacks).

Ask your assisting spectators to turn over their cards, too: each of them has also four identical values (e.g., one the four Queens, the other one the four Kings).

(From my e-book "Enigmaths 8", <http://www.lybrary.com/werner-miller-m-7881.html>)

Middle of the Road

From two contrasting suits (say, Hearts and Spades) sort out the values Ace thru Five into two separate sets. Arrange the cards of each set in numerical order and table them in a face-up spread (Ace on top). Look for a spectator who is willing to participate, then continue either with Option 1 or with Option 2.

Option 1

Let the spectator select one set, you take the other one. Say, the spectator picked the red cards, so you hold the blacks.

Ask the spectator to duplicate, from now on, all your actions carefully.

- Square your cards and turn them over. The spectator does the same with the other set.
- Start an *Under/Down Deal* (top card under the packet, next card on the table, ...), turning each "down" card over before it is tabled. Stop after the fourth card (when a total of two cards have been turned over and dealt to the table); the spectator does likewise.
- Drop your in-hand cards (three face-down cards) as a block on the spectator's face-up tabled pair. The spectator drops his remaining packet on your face-up tabled pair.
- Start another *Under/Down Deal*. Again, each "down" card is turned over and the procedure is stopped after the fourth card. The spectator copies your actions.
- As before, your remaining cards are dropped on the spectator's tabled pair and vice versa.
- Once more, an *Under/Down Deal* is started and stopped as described, and each in-hand packet goes on top of the other tabled pair.

- Fan your cards. The spectator fans his cards, too. The surprising result is shown in Fig. 1: It seems that all the cards are back, and even their order seems to be restored! But wait a minute; let's turn the face-down card in the middle of the fan also face up - it's a 3-spot as assumed, but it's from the other set!

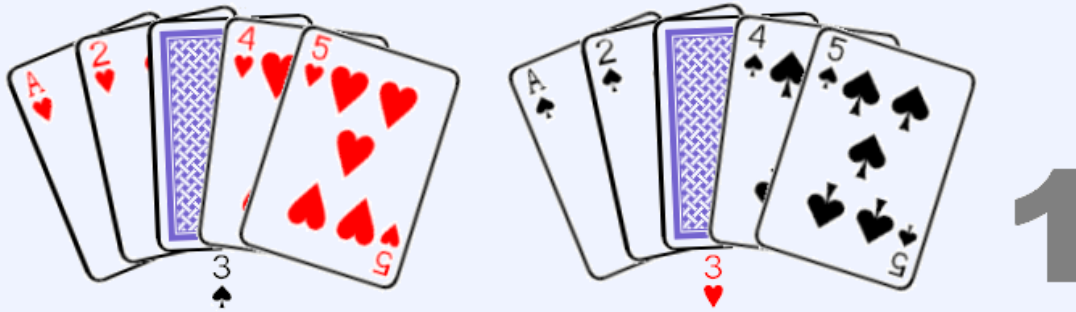

Option 2

Square each set. Combine both sets by placing one on top of the other, turn the combined packet face down and have it completely cut by the spectator.

Give the cards a series of two *Klondyke Shuffles*, then deal them back and forth into two 5-card piles again. (Each pile will contain the same values as before, but of mixed suits. Although the original order of the values is disturbed, the values run still identically in both piles.)

Let the spectator select one pile, the remaining one is yours. Turn your pile face up. (The spectator's pile is left face down.)

From now on, have all your actions duplicated by the spectator:

- Mix your pile *under/down* style. The spectator does the same.
- Swap the top cards, i.e., remove the top card from your pile, wait until the spectator has done likewise, then place your card on the spectator's pile, and have the spectator's card placed on your pile.
- The *Under/Down Deal* is repeated in unison.

Turn your pile over and fan the cards. The spectator's cards are only fanned.

The result (Fig. 2): In each fan the card in the middle is the only face-up card, and their values match!

Deal out your face-up card and ask the spectator to do likewise.

Count aloud "1, 2, 3", and have at "3" both fans turned over simultaneously: In both fans the values are running in the same order!

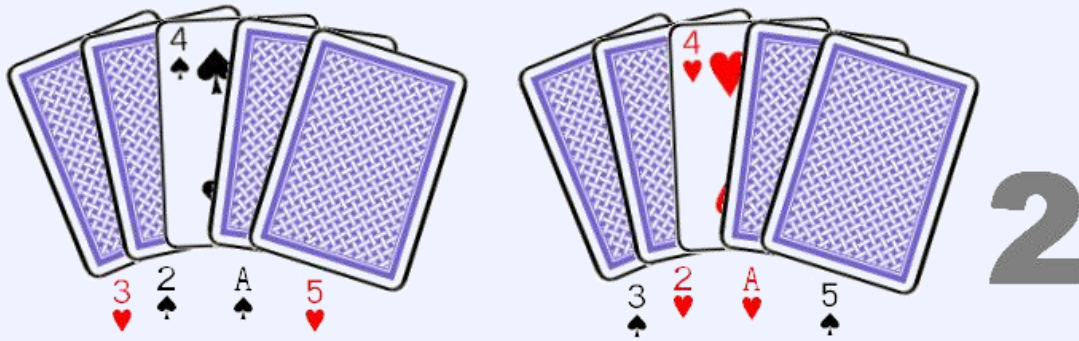

(From my e-book "Enigmaths 9", <http://www.lybrary.com/werner-miller-m-7881.html>)



Visions of Vernon

by Mark Williams



What can be said about Dai Vernon that hasn't already been written? He was known throughout the entire Magic Community as "The Professor". Many magicians from the East Coast lovingly pronounced his nickname as "Day" and magicians on the West Coast referred to Mr. Vernon as "Die". The Professor welcomed all pronunciations of his name and befriended all who came to know him. He was born in Ottawa, Canada to his given name of David Frederick Wingfield Verner. To the Magic Community, Dai Vernon was an innovator of Close-Up Magic and a mentor to many current full-time professionals.

My own journey into the realm of Close-Up Magic started when I was 17 years old. One of the first magic books that I bought was *Stars of Magic*. This one book introduced me to many of the giants within the Magic World. Dai Vernon was among those giants featured in *Stars of Magic*. I learned all of Vernon's material over the course of several years with the hopes of one day meeting "The Man Who Fooled Houdini".

In the summer of 1984, I had just received my latest issue of *Genii Magazine*. Among the articles was an advertisement that caught my eye. The ad copy heralded the New York Close-Up Symposium and promised a fun convention which included some of the top performers of that time. I certainly was interested and since I had never travelled to New York, I thought about all of the famous sites I would get to visit. As I flipped through the pages further, one other advertisement called out to me. The ad lauded the first ever magic convention at sea. *MagicCruise*, as it was called, would be held aboard the S.S. *Rotterdam* sailing to Alaska. It also mentioned that the Guest of Honor would be Dai Vernon. A chance to meet The Professor in person was a chance I was willing to take. So, the thoughts of visiting New York City quickly left my head.

I booked my place for *MagicCruise '84* and felt excited when I finally got to meet The Professor. Dai Vernon was 90 years old; he was a very congenial guy and lived up to all of my expectations. Mr. Vernon was kind enough to autograph my copy of a book he had just published. "Revelations" was Dai Vernon's annotated version of *Expert at the Card Table* (Erdnase).

During that cruise, I was fortunate enough to chat with Mr. Vernon on a more personal level and he was very forthcoming and helpful. I told Dai that I was having issues with flourishes and other similar moves. The Professor told me to find something easier to do, that accomplished the same thing. He told me not to worry and that we all can't be great at everything. Dai finished off by saying that the audience won't know the difference anyway. These words still resound in my thoughts, not only in magic but in everyday life as well.

My visions of Vernon had been fulfilled during the Summer of '84. Yet, my time with The Professor didn't stop there. I was already a member of The Academy of Magical Arts and got to visit with Mr. Vernon at The Magic Castle (Hollywood, Ca.) Each time I sat with Dai upon his couch, I would just listen to his stories and take home new insight into the legend that was The Professor.

Dai Vernon passed away on August 21, 1992 and it was a day that I will always remember. It was Dai's influence that helped me to cement my own affirmation into performing Close-Up Magic. Although my time spent with Mr. Vernon was fleeting, the things I learned from him will continue to inspire me for the rest of my magical journey.

Best Magical Regards,

Mark Williams





Chapter 5

Looking at the needle in his arm, Danny knew that this was not a viable candidate for a lock pick. He had heard horror stories of needles breaking off in people's veins. Such fragile metal would quickly break if he tried to bend it. Danny was certain of that (he only needed a very small length of that needle to bend, which would cause even more stress on the bend). It was not worth the risk of pulling that needle out and possibly tipping his hand to the police.

What was his hand, though? Was he really preparing to attempt an escape? That would only further prove that he was guilty of murdering his wife.

His murdered wife. Emotion began to creep in and tears began to well up. He recalled Tanni crawling into his lap. Suddenly, it was Tanni that he began to worry about and his tears were assuaged. They couldn't just leave the dog in the house, unattended. What must his girl be going through? Where would they have taken her? Too many questions were muddling his thoughts.

The door opened and a doctor entered the room. Danny noticed that he carried a manila folder in his hands, no doubt with his charts and records (and possibly a little something that Danny could use). The doctor left the door open and Danny knew that there would be a police officer posted outside. As his mind raced, he could only hope that the officer had not looked in on him and wouldn't know exactly what he looked like. He surrendered to that glimmer of hope.

"Hello, Mr. Steadman, I'm Dr. Forstein. It seems that you had a minor heart attack and I'd like to discuss that with you."

"Please, doctor, call me Danny."

"Okay, Danny. Do you have a history of heart problems in your family?"

"Not that I know of, doctor, but I was never very close with my family."

Danny liked the low-key, straight-forward manner of Dr. Forstein. Dr. Forstein appeared to be young, but that might work in Danny's favor, he thought.

"What about your parents?" the doctor continued.

"No, nothing there. My dad died three years ago of emphysema, but my mother is still alive and never had any heart problems."

"Do you smoke?"

"Not since my dad died, no."

"So you smoked for how many years?"

Danny had to think that one over. He started smoking when he was 18, but it was cigarillos in those days. It had been a few years before he made the leap from the cigars to cigarettes, maybe when he was 21, he thought.

After some consideration, he replied, "About 25 years, give or take."

"Have you had any heart problems recently, Danny?" the doctor asked.

"No. Well, none that I know of . . ." Danny said that with a bit of a smile on his face and the doctor was sharp enough to figure that out. If he didn't know that he had a minor heart attack now, how would he know of any problems in the past? Danny immediately liked Dr. Forstein and he felt poorly about his brewing plan to manipulate this fine, young doctor.

"Dr. Forstein," Danny began, "how long do you intend to keep me?"

"Well, we have to keep you overnight for observation, but after that you'll be transferred into police custody."

"Into some kind of infirmary?"

"Yes, I suppose . . ."

The doctor's honesty was refreshing.

"May I see my files?" Danny nodded towards the folder in the doctor's hand.

"Well, that's not normally what we do. Are you medically trained?"

"No, not really," Danny responded. "But, I do like to see my records. It's a matter of personal inclination. Curiosity, I suppose."

Danny chose his words carefully. By using 'I suppose' as a way of mirroring the doctor's choice of words, it would tend to get the doctor to comply with his request. Further, he dropped his shoulders and relaxed his chest, which gave the impression of despair, affecting the doctor's empathetic side. All subtle prompts, but they had the impact that Danny was going for.

"Sure," Dr. Forstein said, "I don't see what harm it could do."

The doctor handed over the file and Danny opened the folder up. Danny felt a surge of pleasure blanket him warmly. He saw precisely what it was he was hoping to see - a paper clip holding some of the documents together.

With his left hand he secured the documents to the folder, his thumb over the paperclip in front and his fingers behind the manila folder. Using his right hand, he began flipping the papers up, over the top of the folder, so that he could read the papers underneath, which obscured his left thumb and that much needed paperclip. As he read the papers that he simply did not understand, nor particularly care about, he carefully and gently moved his thumb, paperclip anchored underneath, in a 90 degree angle, sliding the clip above the papers for which it was intended to secure.

As he looked over the last page, he reached up with his right hand and brought all the flipped pages back into the open folder, simultaneously slipping the paperclip out and away from the folder, pinching the clip between his left hand's thumb and index finger, and using that same hand, closed the folder. He handed the folder back to the doctor and thanked him, the paperclip well hidden, while the naturalness of his moves never belied the fact that he had snuck that paperclip out of the folder.

Sleight of hand in its simplest form, Danny thought to himself.

"Are there any questions I can answer for you, Danny?" Forstein asked.

"No, I think I've got everything that I need, Dr. Forstein, thank you."

As the doctor got to the door, Danny threw out one last thing. "Dr. Forstein, is it possible to get a phone to make a call?"

"There's an officer out here. Shall I send him in?"

"No, that's alright. I'm sure I'll have plenty of time, later."

Again, the doctor's aptitude for subtext won Danny over. The hint of a smile on Forstein's face and a knowing look in his eyes told Danny that this guy was deep. Dr. Forstein turned and left the room.

What luck, Danny thought. But even in his musings he realized the irony in that thought. Nothing about this whole situation was lucky. He was suspected of killing his wife, he was falsely accused of resisting the officers, he was trapped in a hospital room, and he'd had a heart attack.

Nevertheless, he knew that he was lucky. Now the real question in Danny's mind was, "How long will my luck hold out?"

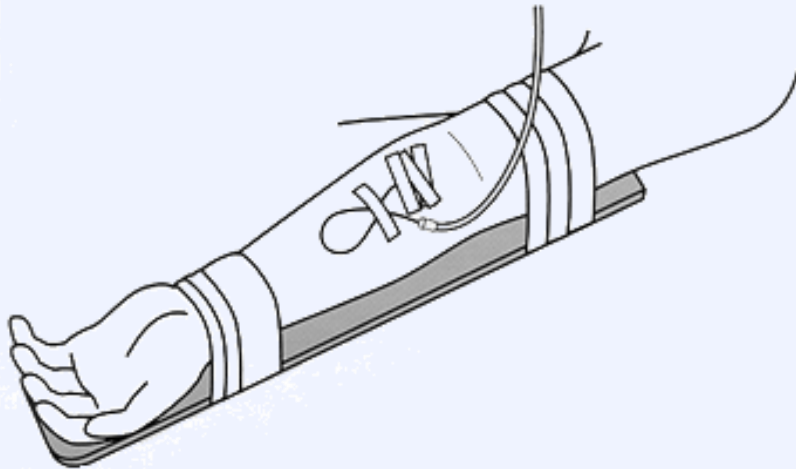

The Magic of Love - A Valentine's Trick

by Jon A. Hand



(AKA *Easy Peasy Waltzer*)

One of the most popular effects for restaurant and close-up performers over the last 20 years has to be ANNIVERSARY WALTZ, originated by Doc Eason and Christopher Carter. In the effect, a married couple celebrating their anniversary is asked to choose a card for the man, and a card for the woman. The cards then become fused together as both sides of a single card, signifying how the couple became one in their marriage.

The effect has become a modern magic classic, with adaptations (read: alterations of method) in print from Carl Andrews, Joshua Jay, and Paul Green, among many others. With Valentine's Day looming, now is a great time to learn a version of this touching and effective card plot.

Using only one Double Facer (DF) in a regular deck, and adapting a trick from the Mark Wilson course, here is my simple take on Anniversary Waltz, which I have dubbed the **Magic of Love** (affectionately known in Magic Bunny circles as **Easy Peasy Waltzer**).

Features:

- Easy execution
- Memorable climax
- Souvenir which the couple can take home
- Optional easy deck switch, useful for other effects
- Simple false cut, also useful for other effects

Simple sleights required:

- Overhand false jog shuffle
- False cut (see description below)

Table spread, and spread turnover

Setup:

Remove the Jokers and advertising card to make room for a DF. Choose a DF with high contrast (red/black, or court/spot). Pull the matching two ordinary cards from the deck, to be forced. Turn the deck face up. Put the DF, with the *lower value showing*, on the bottom of the deck. Put the higher value force card on top of the DF, and then place the lower value force card on top of that.

Check your setup:

With the deck turned face down, the finished setup from top of the deck is 50 indifferent cards, DF with lower value down, high force card, low force card. Case the deck and you are ready to perform.

Deck Switch (if necessary):

If you are doing other card tricks prior to this, you will need a matching second regular deck for those effects. In the course of your set, you will do a deck switch when it is time for **Magic of Love**. Deck switching abounds in magic literature, but here is an easy way: Habitually carry your regular deck in the right jacket pocket, and carry your MoL deck in the left jacket pocket. Finish your card set, dropping the regular deck into your right pocket, and do a non-card effect. Then ask if anyone is in season for an anniversary, bringing the setup deck from the left pocket as you ask the number of the couple's anniversary. With your patter, and the time misdirection of the non-card effect, the deck's coming out of the wrong pocket will fly right by the spectators, as all eyes will be on the couple.

To the proofreader: In the previous paragraph, *deck's coming* is correct, as the noun that modifies a gerund is always possessive]

Version 1, performing with a table:

Bring out the deck from its case as you patter about the anniversary count of the couple and the magic of love to set up the effect. Overhand false jog shuffle, retaining the bottom section of the deck in order, and shuffle the bottom force

card to the top, all during the patter. Status Check: low force card on top, 50 indifferent cards, DF with low value down, and high force card on the bottom.

Simple false cut:

Immediately after the false jog shuffle, prepare for a two-handed cut in-the-hands (not on the table). Hold the deck face down, longwise in front of your body, parallel to the floor. Both hands are palm down, with the index fingers touching each other on top of the deck. The second fingers are touching each other on the spectator's long side of the deck, with the remaining fingers aligned beside them. The thumbs are touching each other on the rear. Most of the deck is thusly hidden by the hands very briefly. While speaking and looking directly at the spectators, you break the deck with the thumbs so that the *left* thumb is holding the *bottom half*, and the *right* thumb is holding the *top half* (just the opposite of a true cut). Pull the hands apart approximately 3", lifting the elbows and the outsides of the hands slightly upward, with the *top* of the deck going into the right hand. The inner ends of the halves are now exposed, being tilted slightly downward due to the lifts of elbows and hands. In the same motion, complete the "cut" by lifting the left index finger from its half and slapping the right hand's cards on top of the left's cards, mimicking a typical in-the-hands cut. Square the deck, ending in the same manner as the starting position. I have used this cut extensively, and, done on the offbeat like the deck switch, it slips right past the spectators.

Table the deck, and ask the wife to cut off half the cards. Lift the bottom half from the table and place it perpendicularly on her cut off portion, which sets up a cross-cut situation as you patter (time misdirection for the cross-cut force). Explain that her cut chose not one card, but two: Pick up the cross-cut section, and turn over your right hand to show the couple the one above the cut (the high value force card, still on the half deck. Then show the one below the cut (the low value force card), by using the left hand to lift the card from the tabled portion of the deck and turn it face upward. *Assign the high value force card to the husband, and the low value force card to the wife.* Replace the left hand card onto the tabled deck portion, face down. Turn the right hand face down and reassemble the deck. The forced cards (and hidden DF) are now *in the center of the deck*. Complete your patter, reminding the couple to remember their individual cards. Square, and table the deck face down.

Tell the wife that the *magic of love* will enable *her* to find *her husband's card* instantly, with only a snap of her fingers, and with no help from you. (Actually true; you have *not* shuffled, or tinkered in any way with the deck after the cards were selected). Have her snap, and then you do a medium width curved table spread, showing the husband's card as the only face up card in the deck!

Slide his card (DF with high value showing) from the spread, and pin it to the table with one finger as you have the husband sign it with a permanent marker. Turn over the spread so that the faces are up. Slide the signed DF anywhere back into the face up spread, and close the spread so that the deck is face up in your hand. Square, turn face down, then table the deck again.

Tell the husband that that same *magic of love* will enable *him* to find *his wife's card* instantly as well, with only a snap of his fingers, and with no help from you. Have him snap, and make a second curved table spread, showing the wife's card as the only face up card in the deck!

Slide her card from the spread, and pin it to the table with one finger as you have her sign it with a permanent marker. Turn over the spread so that the faces are up. Slide the signed DF back into the face up spread, and close the spread so that the deck is face up in your hand. Square and turn face down, then table the deck face down.

Now declare that the *power of their shared love* can do something that not even you as the trained magician can do! Have them hold one another's hand, and lay the couple's joined hands on the deck. Ask them both to snap their free hand's fingers on the count of three. Lift their hands, and table spread the deck for the third time. The *husband's signed card* shows as the only face up card in the deck. Slide the DF card from the spread, and ask the wife to cup her hands together. Lay the DF, husband's signature up, into her cupped hands. Close the spread and case the deck as you patter about the *magic of love* bringing the two of them together permanently.

Ask the wife to turn the card over. There is her signature on her card, joined permanently to her husband's signed card, a lasting souvenir of the *magic of love!*

Version 2, performing without a table:

If you can do a clean pressure fan, you can do the effect all in the hands, omitting the table. Shuffle and false cut as you patter, and place the deck on your flattened right palm. Have the wife cut a section from the deck in your right palm, and ask her to put her cut section into your left palm. Carry the cut by placing the left hand's section perpendicularly onto the right hand section (cross-cut force). Use time misdirection as before, pattering about actually cutting to two cards while intending to cut to one. To show the two selections, use your right hand to lift the crossed section and turn it face up to show the high force card. Use your left thumb to push off the other force card's index, turning your palm inward to expose the card's value to the couple. Assign the high card to the husband and the low card to the wife as in the original description. Reassemble the right hand portion onto the left hand portion normally, and square the deck. The forced cards (and hidden DF) are now in the center of the deck, as before.

Patter to get the wife to snap her fingers, and reveal the husband's face up chosen card from the face down deck using the pressure fan. Out-jog the face up card from the pressure fan, close the fan, and remove the out-jogged card from the deck, laying it on top of the deck for the signature. Remove the signed card from the top of the deck with the right hand. Use the left hand to flip the deck face up, thumb riffle down the left side front corner with left thumb, and insert the signed card into the deck. Flip the deck face down.

Repeat the above paragraph, using the husband's finger snap to find his card. Have him sign it as above, and thumb riffle to insert it back into the now face up deck. Flip the deck face down.

After the couple joins hands on top of the deck in your left hand, have them snap together with their free hands. Make a pressure fan for the third time, remove the husband's face up signed card, *and lay it into the wife's cupped hands.* Patter about the permanent joining of their lives, and have the wife turn the card over to see *her signed card permanently joined to her husband's.*

Notice these aspects:

This is clean and direct. There are no Double Lifts, no Double Backer, no shuffling or tricky handling of the deck by the magician after the cards are selected, no excuse for signing the back of the card instead of the face, and the couple causes all the magic to happen by themselves! You are left with a clean deck if you want to do other card tricks later, and the happy couple gets a souvenir of the magic to take home.

Although this version is not impromptu, it is worth having a deck set up for it if you know you are going into the situation, or if you work regularly in close-up venues. Have fun with it; I think you will enjoy it because *the couple's love does ALL the magic.*





Bizarre Bursary

Our bizarre offering today, Kiddies, is a wonderfully twisted routine from our friendly resident undertaker, Weepin' Willie. Only those with the greatest of intestinal fortitude should peruse his deliciously twisted routine...



Ned

by Weepin' Willie



Well, another year in the past and The House of Discount Funerals and Birthing Center is still in the red. Not financially, but ... well, you understand. I hope all of you had a Merry Christmas and are looking forward a Happy and prosperous New Year. If so, then you have been blessed because it is not always so everywhere for everyone because Death is no respecter of persons, places, things, or times. It is during such joyful times, such as Christmas, that the Death Angel visits and ruins the festive atmosphere for years to come. Such was the situation at the Bonnor household this year. The night before Christmas, and all through the house, not a creature was stirring and that included Mom. Mom passed away and we did not know why. Just that afternoon she seemed her normal self, palsied speech, vomiting, and falling all over the place; nothing unusual. But once we checked the surveillance camera the mystery was solved. Mom had a visitor in the night and it was not Jolly Ole Saint Nick but an impostor. I have included a portion of that footage for your perusal. As sad as it may seem, everyone was still thankful because the gifts had not been opened and most of them were returnable. Other than standing in the long return line, it was a good holiday and we sat Mom at the dinner table just like always and the grand kids kissed her goodbye as they left for home.

XX

The Fair was always an anticipated event in Hayville, ranking second only to the Annual Death Festival and Shriner Parade. It was usually a six day event that always started the second week of October. I do not know if it was the nature of weather or the judgment of God, but it always rained that week. But, just like returnable gifts at a holiday death, the rain did not damper the spirits of those who came out in wet gear to wade through the mud. They once tried to change it to a Spring Fair in May, but it rained then, too, so the Fair date was moved back to October. Besides, it interfered with the May Pole Dance Competition. "One week long festival is enough," it was decided by the Hayville town council.

Of course, my favorite is the November Death Fair, an event for merchants in the Death Industry to display their skills and wares, so the timing of the fair was not an issue for me. There was always a display of coffins and urns, some for use and some just for display, and I always displayed a cadaver or two posed in a life-situation stance like smoking or watching television to remind everyone that it is in the midst of life that Death makes his appearance and, as such, Death is only an extension of life.

I have to watch the cadavers constantly because the young hoods would pose them in compromising positions if they found them alone, especially if they were male and female. I always sign up several pre-planning clients during that week, some just wanting to pose with the cadavers on display now. Do not get me wrong, spring is always a joyful time when the birds and lovers come out, but nothing compares to the feeling of release after a funeral planning and the Death Fair accomplished that, too.

It was at one such October, Town Fair, so long ago I do not remember the year, that Ned came to be a resident in our fair town. Ned had always wanted to be a professional magician and he and his wife, who was his "lovely assistant" were pretty successful until a prop went wrong and he actually sawed her in half. "People pay good money to see you saw someone in half, and when you actually do it, they want their money back and no one wants to hire you; go figure." Ned explained.

It became Ned's fate to join the circus, where he learned many skills, particularly the gaming scams. I learned a lot of my Funeral Parlor magic from Ned, as we would sit around a table and drink coffee at the parlor.

This particular year, Ned had come to Hayville with the circus, and while eating lunch, Dobo the Elephant sat on his leg and broke it in several places. Unable to travel when the Fair left town, Ned was left behind. Most would have been depressed, but not Ned. He decided to use his Circus-learned skills to occupy himself and became a life-long resident by opening Ned's Used Car Lot. I will never forget when Richard came to town and commented on the one, rusty, dilapidated car on Ned's lot.

Richard: "How can you make a living with just one old car?"

Ned: "I can tell, you never did understand them carnie games, did you, boy?"

Indeed, it was the gaming skills he learned that gave Ned the edge. "Ain't much difference between working the carnival games and selling used cars," he would say, "Both operate on lies and deception and you can't win either, unless I want you to." I guess he was right because he always seemed to have more money than an insurance salesman.

Ned was always fun to be around and many times I watched as a new comer would drop by. Ned always had a small bag of Lance salted peanuts and a six-ounce Coca Cola. He would welcome the strangers and show them the empty bag, that had contained the peanuts a few moments earlier, and the empty coke bottle.

"I wonder if a six-ounce coke could fit in this bag," He'd ask.

"I wouldn't think so," the strangers would say.

Obviously, the bag was much too small to hold six-ounces of liquid. It was only about two inches wide and four inches long. Maybe two ounces at the most, but definitely not six.

"I really think it would." Ned would egg them on.

"No, no way. The bag is too small."

"Well, would you bet on it?"

After a few moments the strangers would be so set that if it were possible they needed to know and their curiosity would get the best of them. I have seen the bet go as high as a hundred dollars. Once the bet was secured, Ned would ask the waitress to fill up the Coke bottle to the top, more than it was filled with coke at the bottling plant. While waiting on the bottle, Ned would work his magic. You must understand, the success of every carnie scam depends upon the operator knowing something that you do not, and Ned was the master of carnie scams.

In those days the peanut bags were double lined to provide freshness because the peanuts were not preserved with anything much more than salt. The bag was formed by taking a larger bag and folding it and sealing it. If you were careful, you could take them apart and unfold them to create a bag with more than four times the volume of the little bag. When the bottle of water returned, he would pour the contents into the bag with room to spare.

"Make a Mark lose a bet and you fool him one time and make him mad, but teach him how he lost and he is your friend forever. Nobody likes to lose money foolishly, but if it's an education they don't mind." Ned always said. And he was right. People always cheerfully paid him the bet and never complained about the trickery because they had been taught something they could use themselves to win more money back than they had lost to Ned. It is a shame that the bags are no longer double lined. The Coke and

peanut bag trick was only one of many bar tricks Ned would do and people never got mad because it was worth what they lost to be entertained and educated.

Ned had a lot of wisdom and a lot of talent, but Ned was always being wooed back to stage magic. It was this obsession that cost Ned his life. We were called to pick up his body at his home and it was obvious that he had been practicing the bullet catch trick, an effect that had already taken the life of more than a dozen magicians before him. Being a loner and having no family, his obituary did not tell what a great husband or father he was or how faithful he was to any organization. It simply said, "Ned's Dead!"

The Bullet Trick

This was one of Ned's favorite tricks because it only required one person to do it and a shaky handed assistant wasn't in the equation. When Ned did this trick he would let the spectator choose one of six bullets, only one of which was a dud. He'd place the single bullet in the wheel gun, point it at his head, and click! Nothing. The shock value of the effect was tremendous and the audience almost sucked all the oxygen out of the room when they gasped. When Ned had that accident and killed himself I added the routine to my magic shows at the Funeral Emporium but changed my mode of operation. I'd ask for a volunteer, let them choose the bullet, place it in the gun, point it at their head and pull the trigger. Click! Nothing. You should have seen the look on the volunteer assistant's face when that gun went click and nothing happened, it was so funny to see their eyes bulge out with terror and sweat soak their clothing. A few even peed themselves. However, like most magic tricks sometimes things don't always go as planned and after a night of sniffing embalming fluid the trick went horribly wrong and instead of Click! The gun went Bang! You should have seen the look of puzzlement on the spectator's faces that day as a hole formed between his eyes and his brains painted the crowd behind him. The prosecutor claimed murder in the first degree but the defense said that since the person not only volunteered but choose the bullet himself, it was clearly a case of magician assisted suicide. With a generous offer of free funerals for life, the judge agreed. I decided to change the method for doing the trick and with all the anti-gun hype going around decided to not use the gun at all.



Effect: The performer brings out six bullets and lines them in a row, lead side up. The spectator freely chooses a number between one and six and the bullet at that location is the only one that has a busted cap. If you want to spend the time, you can use empty casings with wooden plugs and notes attached that say 'click' except for one that says, 'bang'.

Or you could just use six coins marked with the words. The only requirement is you need six identical items with one marked differently than the others but not able to be

seen by the spectators until the reveal. You are only limited by your own imagination and the tolerance of the audience. (As a tip, dog turds don't work well for this effect because you can't pick them up by the clean end).



Preparation: You will need six bullets. Any caliber will work but I like to use a larger caliber because it is visual. Besides, if you use the wooden plug type of bullets you will need the room for the note. In this case, I prefer to use .40 caliber brass. The reason I prefer .40 caliber is because one caliber equals one inch and a 3/8 inch wooden plug will fit nicely in a .40 caliber shell casing. (You could slice pieces off of a dowel but why do more work than necessary when you can use the plug? At the Death Emporium we never waste time cutting off legs that are too long for the economy size coffin, we just fold the legs at the knees). If you decide to use the plug version, I use a knife or thin saw to score the wooden plug bullet across the middle to allow me to put a piece of cardboard or paper in the slot and glue it down. Remember: "All except one has the word, "Click" printed on it and the final one, "Bang!" I place the wooden plug bullet into the shell with the cardboard or paper slip inside. From the outside, no one can tell which is which. When you place the bullets in the tray, you make sure the one with "Bang!" is third from the left.

If you decide to use the bullets, use a pair of pliers and a rag to carefully remove the bullet, dump the powder, and bust the cap in the gun. Then replace the bullet into the casing. Another option is to use six live rounds and just color one primer black with a marking pen. Like I said, there are many options available. You can even put hooks in the wooden plugs to make them easier to remove and replace.

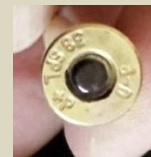

Workings: This method of forcing a particular item out of six is popular in the effect, "Hot Rod", where you have someone choose a number and their number selects a color and all the gems turn to that color. Ned used this force a lot and I am sure it is older than that and has been used for many other effects. You ask the spectator to select a number from one to six, including one and six. It is important that they understand that they may choose one and six and not just two, three, four, and five. Say they choose 1, you spell from your left, "O.N.E", which bring you to the third from the left, the chosen bullet. If they choose two or six you do the same and still come to the third selection. If they choose three you count, "1.2.3" If four or five you spell from your right, instead of the left. You will always end upon the third from your left.

To add suspense, you reveal their selection.

Other Suggestions: You can repeat this effect if you use the magicians force for the second revelation instead of the counting method. Have fun and be creative.

Production Team

Designer & Publisher: Michael Jay

Editor: Michael Jay

Proof Readers: Gary Scott

Shaun Robinson

Scott Fridinger

Paul Rey

Technical Advisor: Wayne Clancy

Assistant Tech Advisor: Tam McLaughlin

Based on the design of Wayne Trice

The next issue of Top Hat is due out the 15th February. If you are interested in submitting an article for publication please direct your inquiry to tophatv2@gmail.com

If you have any comments, questions or criticisms, please send them to the e-mail address above. We welcome all feedback.